

REVISIONS			
REV.	DESCRIPTIONS	EDIT BY	DATE:(d/m/y)

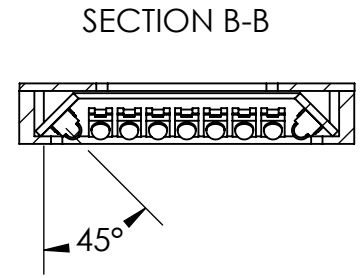
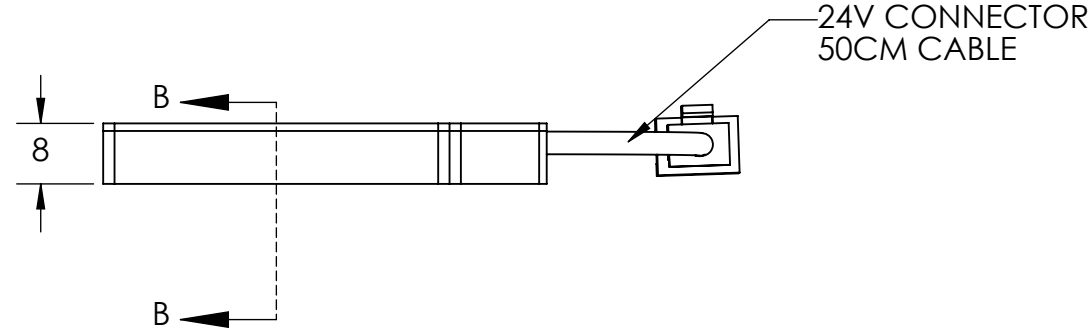
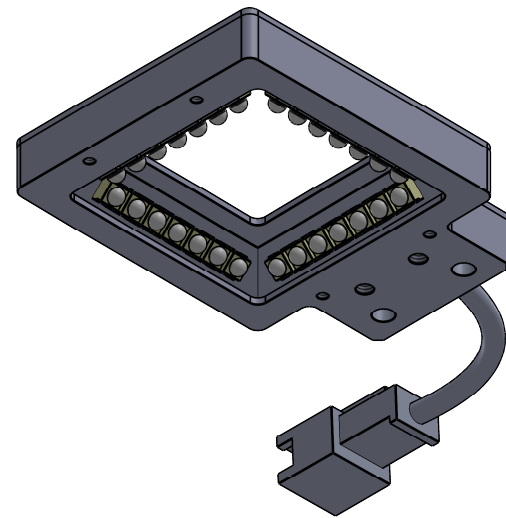
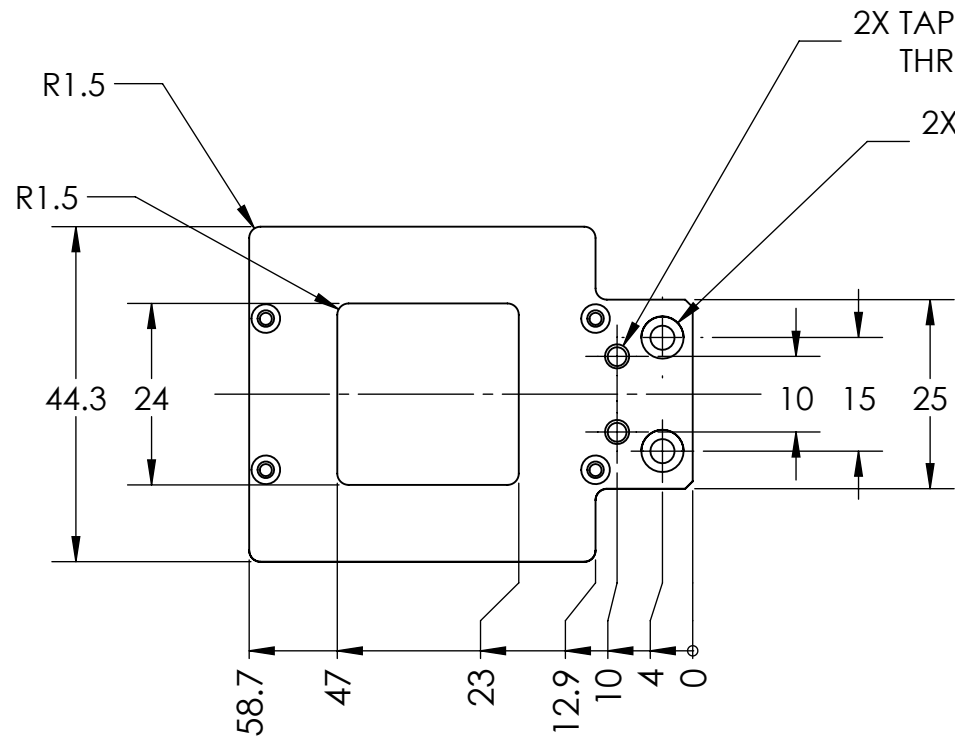

DESIGN BY	FIRDAUS	UNIT: MM	PRODUCT SERIES: LSQF SERIES	
CHECK BY	NIZAM	SIZE A4		
DATE	1/6/2022	REVISION:	TITLE	DRAWING LAYOUT
MATERIAL	-	01	PART NO	LSQF-45-045-1-X-24V
FINISHING	-	SCALE:	DWG NO	-
QTY	-	1:1	GEN. TOLERANCES	
X ±0.15				
X.X ±0.1				
X.XX ±0.05				
SHEET 1 OF 1				