

REVISIONS			
REV.	DESCRIPTIONS	EDIT BY	DATE:(d/m/y)

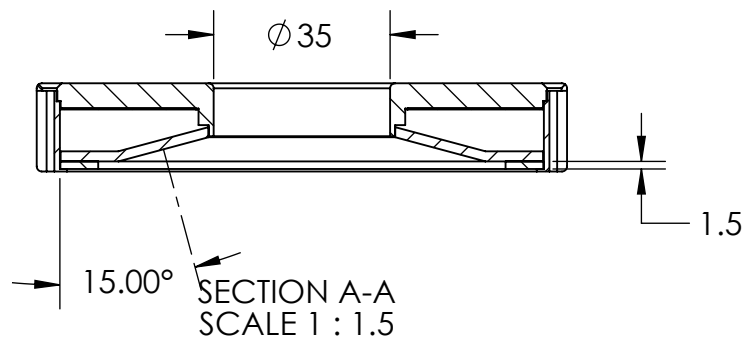

DESIGN BY	FIRDAUS	UNIT: MM	PRODUCT SERIES: DFR4 SERIES	
CHECK BY	NIZAM	SIZE A4		
DATE	3/6/2022	REVISION:	TITLE	DRAWING LAYOUT
MATERIAL	-	01	PART NO	DFR4-15-100-1-X-24V
FINISHING	-	SCALE:	DWG NO	-
QTY	-	1:1	GEN. TOLERANCES	
			X	±0.15
			X.X	±0.1
			X.XX	±0.05
			SHEET 1 OF 1	

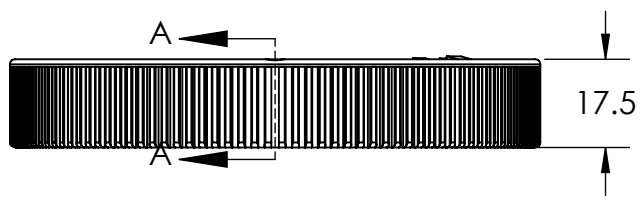
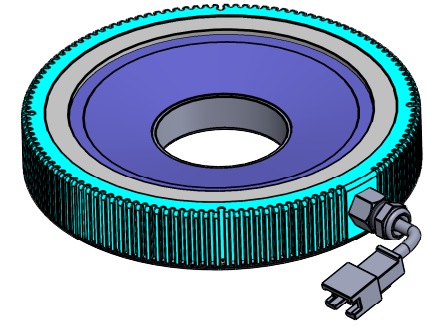
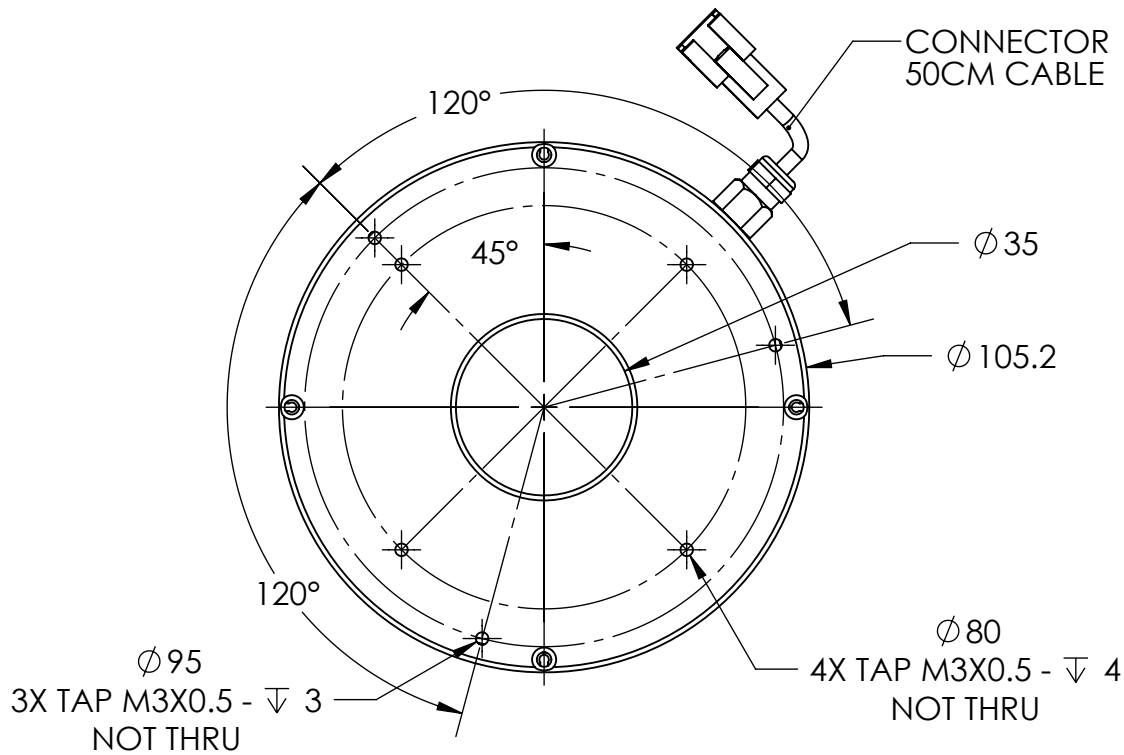