

▪ 2048 x 1536

▪ 36 fps

Go-X Series 

GigE
VISION

➤ **GOX-3201-PGE**
3.2-megapixel CMOS global shutter



- *Go-X Series delivers exceptional combination of price and performance*
- *3.2-megapixel, 1/1.8" CMOS imager (global shutter)*
- *Up to 36.5 fps at full resolution (2048 x 1536)*
- *3.45 μm square pixels*
- *8/10/12-bit* output in choice of monochrome or raw Bayer color models*
- *ROI settings for added flexibility*
- *Horizontal/vertical image flip function, plus blemish correction and shading compensation*
- *Includes Sequencer function and Automatic Level Control (ALC) for dynamic lighting conditions*
- *Compact size with excellent shock and vibration resistance*
- *Accepts power over GigE Vision interface or separate 6-pin connector*
- *C-mount lens mount*

* Not all processing functions supported with 12-bit output.

Specifications for GOX-3201-PGE

Go-X Series

Specifications		GOX-3201-PGE
Sensor	1/1.8" CMOS global shutter (IMX265)	
Active pixels	2048 (h) x 1536 (v)	
Frame rate	36.5 frames/sec. @ 8-bit mono/Bayer	
Active area	7.07 mm (h) x 5.3 mm (v) - 8.83 mm diagonal	
Pixel size	3.45 μm x 3.45 μm	
System clock	74.25 MHz (for pulse generator)	
Read-out modes	Full ROI (single) 2048 (h) x 1536 (v) up to 36.5 fps H: 96 - 2032 pixels in 16-pixel steps V: 8 to 1534 lines in 2-line steps Binning 1x2, 2x1, 2x2 (mono only)	
EMVA 1288 Parameters	10-bit output format	
Absolute sensitivity	Mono: 3.29 p Color: 3.58 p (λ = 527 nm)	
Maximum SNR	Mono: 39.7 dB Color: 39.7 dB	
Traditional SNR*	>60 dB mono, >60 dB color (0 dB gain, 10-bit)	
Video signal output	Monochrome: 8/10/12-bit [†] Color: 8/10/12-bit Bayer [†]	
Gain control	Manual/auto 0 dB to +24 dB	
White balance	Off, presets, or one-push/continuous AWB	
Gamma/LUT	0.45 to 1.0 (9 steps) or 257-point programmable LUT	
Synchronization	Internal	
Video modes	Normal/Single ROI, Sequencer (Trigger & Command)	
Trigger input	Opto In, Pulse Generators (4), Software, NAND Out (2), User Output (4)	
Exposure modes	Timed/EPS, RCT, Trigger Width, Auto	
Electronic shutter	Timed: 14.73 μs to 8 s in 1 μs steps Auto: 100 μs to 27.3 ms at full resolution	
Auto Level Control (ALC)	Shutter range from 100 μs to 27.3 ms, gain range from 0 dB to +24 dB. Tracking speeds and max. values adjustable.	
Shading correction	Flat shading, color shading (color model)	
Pre-processing functions	H & V flip (mirroring), blemish compensation, H & V decimation	
Operating temp. (ambient)	-5°C to +45°C (20 to 80% non-condensing)	
Storage temp. (ambient)	-25°C to +60°C (20 to 80% non condensing)	
Vibration	10G (20 Hz to 200 Hz, XYZ directions)	
Shock	80G	
Regulations	CE(EN 55032:2015(CISPR32:2015), EN 55035:2017(CISPR35:2016)), FCC Part 15 Class A, RoHS/WEEE, KC	
Power	6-pin PoE	+10V to +25V DC. 2.7 W typical @ +12 V +36V to +57 V DC. 3.7 W typical @ +48 V
Lens mount	C-mount	
Dimensions (H x W x L)	29 mm x 29 mm x 51.5 mm	
Weight	65 g	

Ordering Information

GOX-3201M-PGE	Monochrome camera with GigE Vision interface
GOX-3201C-PGE	Color camera with GigE Vision interface

*Traditional SNR is based on random noise in a single frame, where EMVA SNR measurements consider more comprehensive noise sources and variance over time.

†12-bit output only available in video processing bypass mode. See manual for details.

Europe, Middle East & Africa
 Phone +45 4457 8888
 Fax +45 4491 8880

Asia Pacific
 Phone +81 45 440 0154
 Fax +81 45 440 0166

Americas
 Phone (Toll-Free) 1 800 445 5444
 Phone +1 408 383 0300

Visit our website on www.jai.com

Dimensions

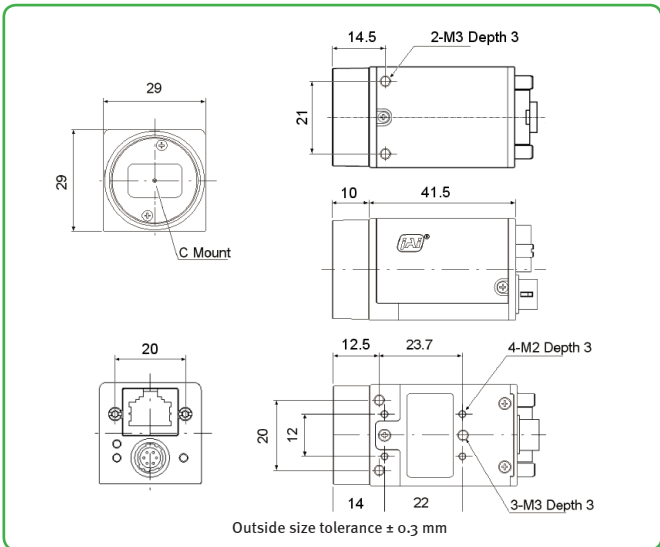

Connector pin-out

DC In / Trigger

HIROSE HR10A-7R-6PB(73)

Pin	Signal
1	DC in +10V to +25V
2	Opto In+
3	Opto In-
4	Opto Out+
5	Opto Out-
6	Ground

GigE Vision Interface

RJ-45 with locking screws

Pin	Signal
1	TRD+ (0)
2	TRD- (0)
3	TRD+ (1)
4	TRD+ (2)
5	TRD- (2)
6	TRD- (1)
7	TRD+ (3)
8	TRD- (3)

Spectral response

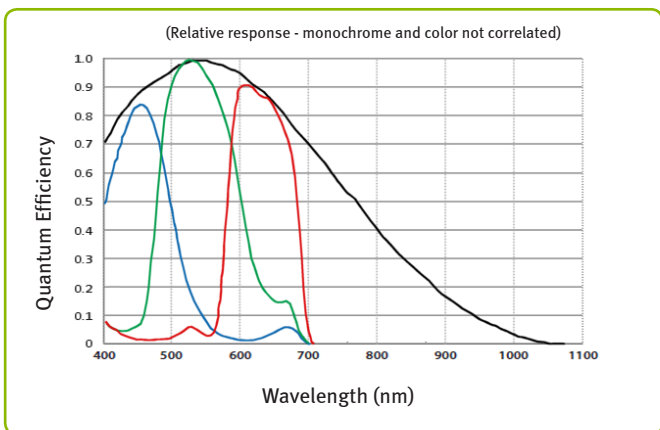

Company and product names mentioned in this datasheet are trademarks or registered trademarks of their respective owners. JAI A-S cannot be held responsible for any technical or typographical errors and reserves the right to make changes to products and documentation without prior notice.



See the possibilities