

Prosilica GC 650



- GigE Vision interface
- Rugged housing
- IEEE 1588 PTP
- Auto iris

Compact performance

Prosilica GC - Ultra-compact GigE Vision camera

Prosilica GC 650 with Sony ICX424 runs 90.0 frames per second at 0.3 MP resolution.

The Prosilica GC is a GigE camera with an ultra-compact, lightweight housing, fast frame rates, and auto-iris control. It offers a large choice of CCD and CMOS sensors up to 5 Megapixels and fits a wide range of applications.

Easy software integration with [Allied Vision's Vimba Suite](#) and compatibility to the most popular third party image-processing libraries.

See the [Modular Concept](#) for lens mount, housing variants, optical filters, case design, and other modular options. See the [Customization and OEM Solutions webpage](#) for additional options.

Specifications

Prosilica GC 650	
Interface	IEEE 802.3 1000baseT
Resolution	659 (H) × 493 (V)
Sensor	Sony ICX424
Sensor type	CCD Progressive
Shutter mode	Global shutter
Sensor size	Type 1/3
Pixel size	7.4 μm × 7.4 μm
Lens mount (default)	C-Mount

Prosilica GC 650	
Max. frame rate at full resolution	90 fps
ADC	12 Bit
Image buffer (RAM)	16 MByte
Output	
Bit depth	8/12 Bit
Monochrome pixel formats	Mono8, Mono12, Mono12Packed
RGB color pixel formats	RGB8Packed, BGR8Packed
Raw pixel formats	BayerRG8, BayerRG12, BayerGR12Packed
General purpose inputs/outputs (GPIOs)	
TTL I/Os	1 input, 1 output
Opto-isolated I/Os	1 input, 1 output
RS232	1
Operating conditions/dimensions	
Operating temperature	0 °C to +50 °C ambient (without condensation)
Power requirements (DC)	5 to 25 VDC
Power consumption	3 W at 12 VDC
Mass	99 g
Body dimensions (L × W × H in mm)	59 × 46 × 33 (including connectors)
Regulations	CE: 2014/30/EU (EMC), 2011/65/EU, including amendment 2015/863/EU (RoHS); FCC Class A; CAN ICES-003

Quantum efficiency

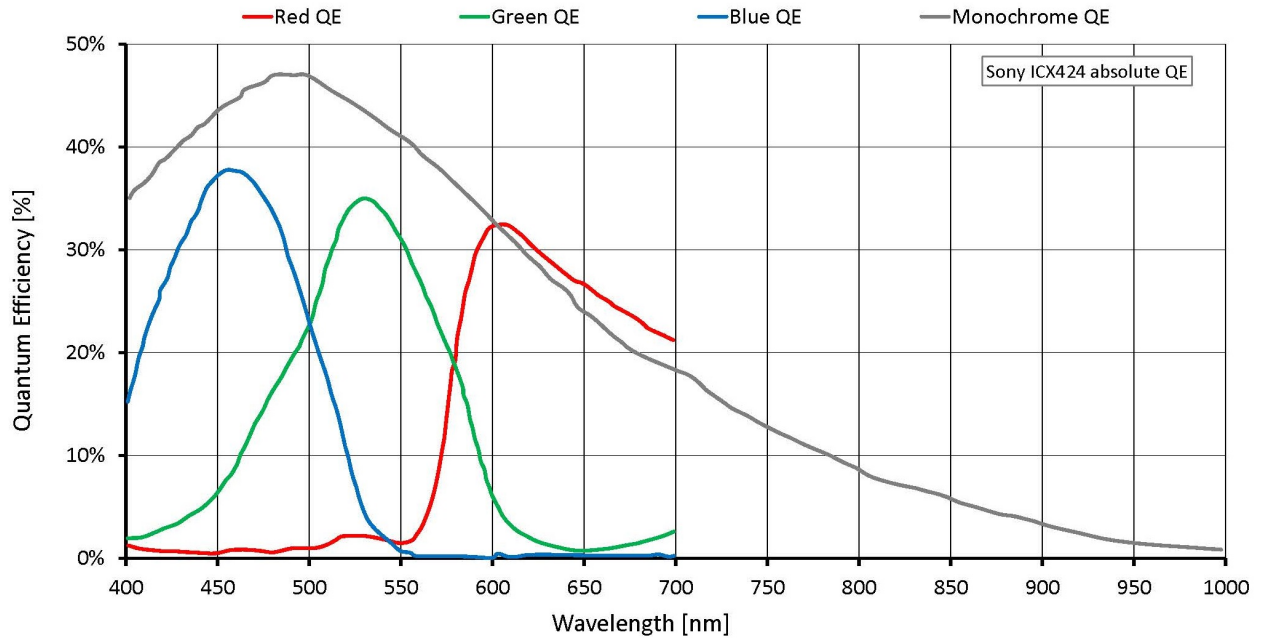

Features

Image control: Auto

- Auto exposure
- Auto gain
- Auto white balance (color models)

Image control: Other

- Binning
- ROI (region of interest)

Camera control

- Acquisition frame rate
- Auto iris
- Bandwidth control

- Event channel
- Firmware update in the field
- I/O and trigger control
- Image chunk data
- PTP (IEEE 1588 Precision Time Protocol)
- Stream hold

Technical drawing

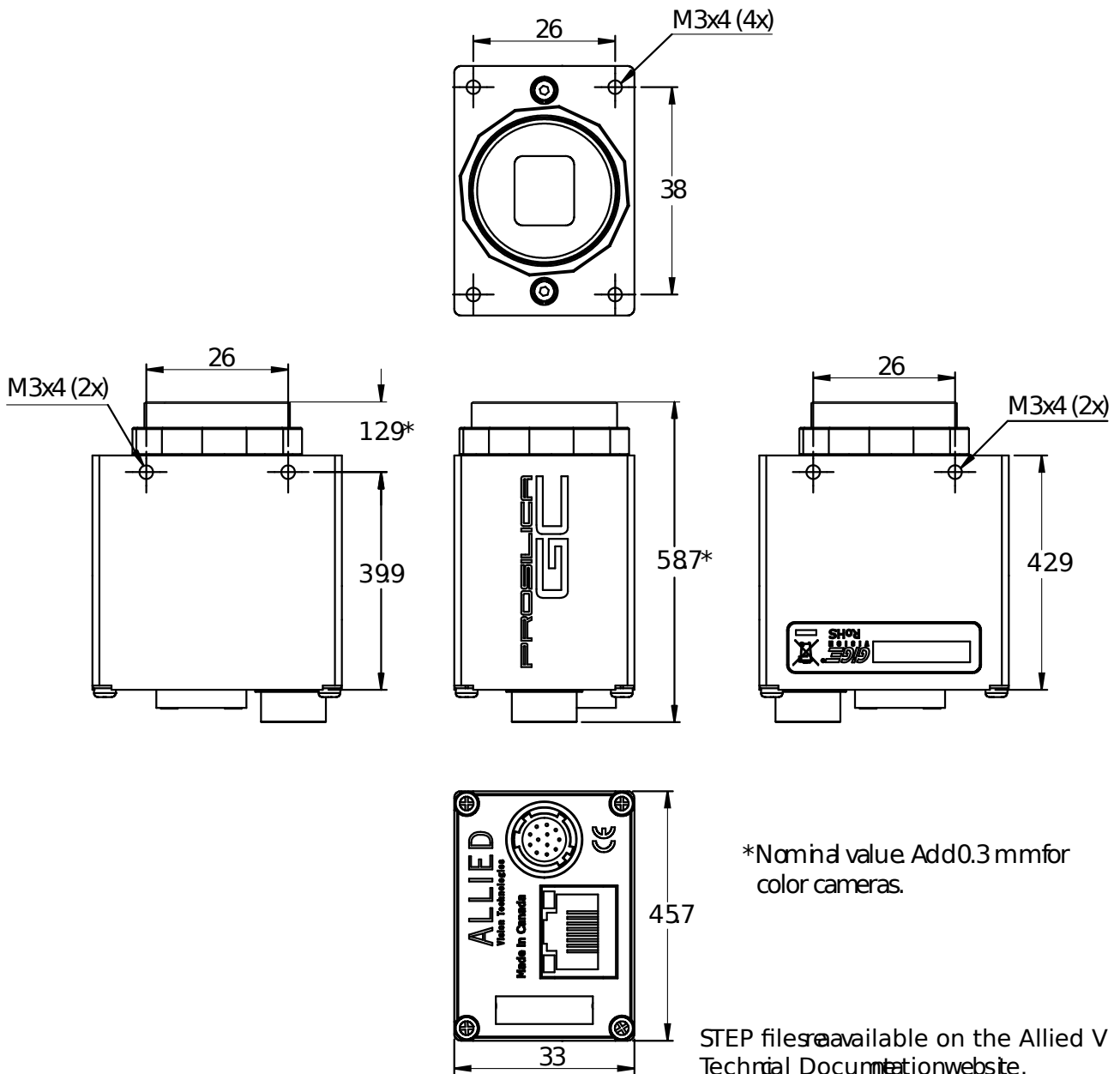



Applications

Prosilica GC650 is ideal for a wide range of applications including:

- Machine vision
- Industrial inspection
- Public security
- Traffic monitoring
- Robotics